



深圳市蓝宝安科电子有限公司

Shenzhen LanbaoAnke Electronics Co.,Ltd.

承认书

APPROVAL SHEET

编号 NO.	LB-RT20-02
版次 Ver.	A/3

客户 Customer	
-----------------------	--

品名 Product	陶瓷管保险丝
系列 Series	RTI-20

料号Part No.		规格描述Specification	备注Remark
蓝宝 LB fuse			
客 户 Customer			

供应商-蓝宝 Supplier-LB fuse		零件承认章 Approval Signet	客户 Customer	零件承认章 Approval Signet
制作 Make				
审查 Check				
批准 Approval				

联络Contact			
业务Sales	电话Telephone	手机Cellphone	邮箱E-mail
			lanbaofuse@163.com

零件承认后敬请回签一份给我司留存。

History of Change变更记录

NO.	日期 Date	描述 Description	版次 Edition	修改 modified by	审核 Checked by
1	2020.11.24	新制订	A/1		
2	2023.04.03	更改为新封面	A/2		
3	2023.12.15	新增14.2 PN编码规则	A/3		
4					
5					
6					
7					
8					
9					
10					
11					

1. 适用范围 / SCOPE

RTI-20(2T) 系列小型保险丝，适用于一般电子设备。

RTI-20(2T) series Miniature-Fuse, used in electronic equipment.

2. 产品型号 / TYPE:

例「example」:

RTI-20	T	2A	L	250V	
1	2	3	4	5	6

- ① 系列号 / Series Number
- ② 慢断 / Time-Lag
- ③ 额定电流 / Rated Current
- ④ 分断能力 / Low BC
- ⑤ 额定电压 / Rated Voltage
- ⑥ 认证符号 / Approved Symbol

3. 额定电流和额定电压 / RATED CURRENT AND RATED VOLTAGE

额定电流 / Rated Current:

100mA~16A

额定电压 / Rated Voltage:

250VAC

4. 标示 / MARKING

保险丝上需要有下列标示 / The fuses shall have the following marking:

- ① 制造工厂的标示 / Manufacture is Logo: **LB**[®]
- ② 电气特性 / Electrical Characteristic: T (延时性的保险丝符号 symbol for Time-Lag)
- ③ 额定电流 / Rated Current (A): ___ A 或 ___ mA
- ④ 额定电压 / Rated Voltage (V): ***V
- ⑤ 认证符号 / Approval Marks: 

注意 / Note:

对标示的大小和位置没有规定 / Size and position of the markings shall not be provided.

5. 外观及形状 / APPEARANCES AND CONFIGURATION

5-1 外观：不应有破碎、明显的污斑。

Appearances: There shall not be break up and any remarkable blotch.

5-2 形状：带脚或不带脚的小型保险丝。

Configuration: Small fuses with or without feet

6. 工程图和结构 / OUTLINE DRAWING AND STRUCTURE

6-1 工程图（单位：mm） / Outline Drawing and Dimensions (Unit: mm)

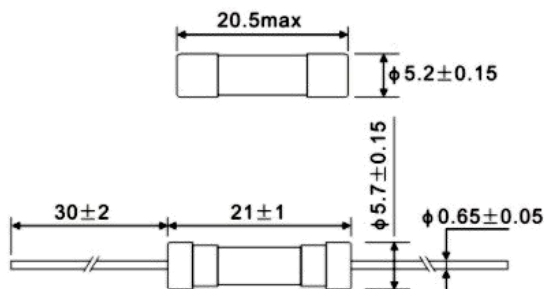

6-2 结构 / Structure

编号 No	元件 Component	材质 Material	数量 Quantity
①	熔丝 Wire	合金 Alloy	1
②	铜帽 Cap	黄铜镀镍 Brass with nickel plated	2
③	本体 Body	陶瓷管 Ceramic Tube	1
④	引线 Lead	镀锡铜线 Tinned Copper wire	2
⑤	填充物 Lead	石英砂 Quartz sand	选装项

7. 产品特性 / PRODUCT CHARACTERISTICS

7-1 引脚拉力强度 / Lead Pull Strength

10 牛顿 10±1 秒 / 10N for 10±1 Sec.

7-2 引脚推力强度 / Lead Thrust Strength

2 牛顿 10±1 秒 / 2N for 10±1 Sec.

7-3 可焊性 / Solderability

波峰焊/Wave : 260°C, ≤3s;

烙铁焊/Soldering Iron: 350±10°C, ≤3s.

7-4 耐焊接热 / Soldering Heat Resistance

波峰焊/Wave : 260°C, 10s;

烙铁焊/Soldering Iron: 350°C, 5s.

8. 电气特性 / ELECTRICAL CHARACTERISTICS

8-1 熔断 / 电流特性: Pre-Arcing Time / Current Characteristic (limits)

In accordance with IEC60127-2 standard, sheet5 / 遵循 IEC60127-2, 规格单5

RATED CURRENT	Of Ampere Rating 额定电流%	Opening Time 熔断时间
100mA to 6.3A	150%	1 Hr Min. / 最短1小时
8A to 16A		30min Min. / 最短30分钟
100mA to 16A	210%	2min Max. / 最长2分钟
20A		30min Max. / 最长30分钟
100mA	275%	200ms Min. 10s Max. / 最短200毫秒, 最长10秒
200mA to 16A		600ms Min. 10s Max. / 最短600毫秒, 最长10秒
20A		200ms Min. 120s Max. / 最短200毫秒, 最长120秒
100mA	400%	40ms Min. 3s Max / 最短40毫秒, 最长3秒
200mA to 16A		150ms Min.3s Max. / 最短150毫秒, 最长3秒
20A		50ms Min.10s Max. / 最短50毫秒, 最长10秒
100mA	1000%	10ms Min.300ms Max. / 最短10毫秒, 最长300毫秒
200mA~16A		20ms Min.300ms Max. / 最短20毫秒, 最长300毫秒
20A		5ms Min.300ms Max. / 最短5毫秒, 最长300毫秒

9. 环境特性 / ENVIRONMENTAL CHARACTERISTIC

9-1 操作温度范围: -55°C~125°C / Operating Temperature:-55°C~125°C

若贵司操作环境温度超出25±5°C范围, 在选用保险丝规格时, 需考虑操作环境温度对保险丝的影响。

请参照: 温度-电流曲线图。

When choosing the fuse's specification, if the operating environmental temperature beyond the scope from 20~30°C, you should consider the environmental temperature's affection to fuses.

Please refer:

Temperature-Current curve:

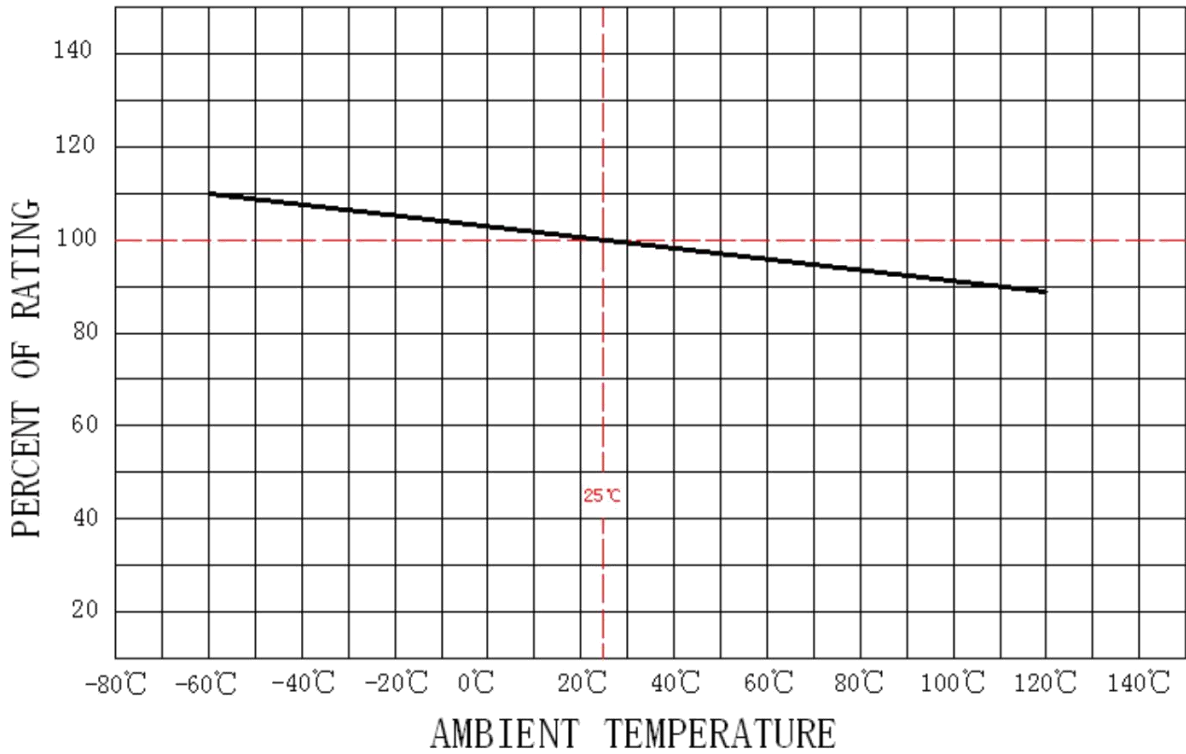

9-2 存储条件 / Storage Conditions

在温度+10°C~60°C、相对湿度 $\leq 75\%$ 的密闭条件下可存放 3 年。

Under airtight in temperature+10°C~60°C、relative humidity $\leq 75\%$ can store 3 years.

在温度+10°C~60°C、相对湿度为 95%的非露天下最多可存放 30 天。

Without dew in temperature+10°C~60°C、relative humidity be 95% maximum value for 30days.

10. 安装方式及条件 / INSTALLATION WAY AND PARAMETERS

10-1 建议如下图安装方式安装，并满足所要求的尺寸。

Propose that the following picture installation way is installed, and satisfied the required size.

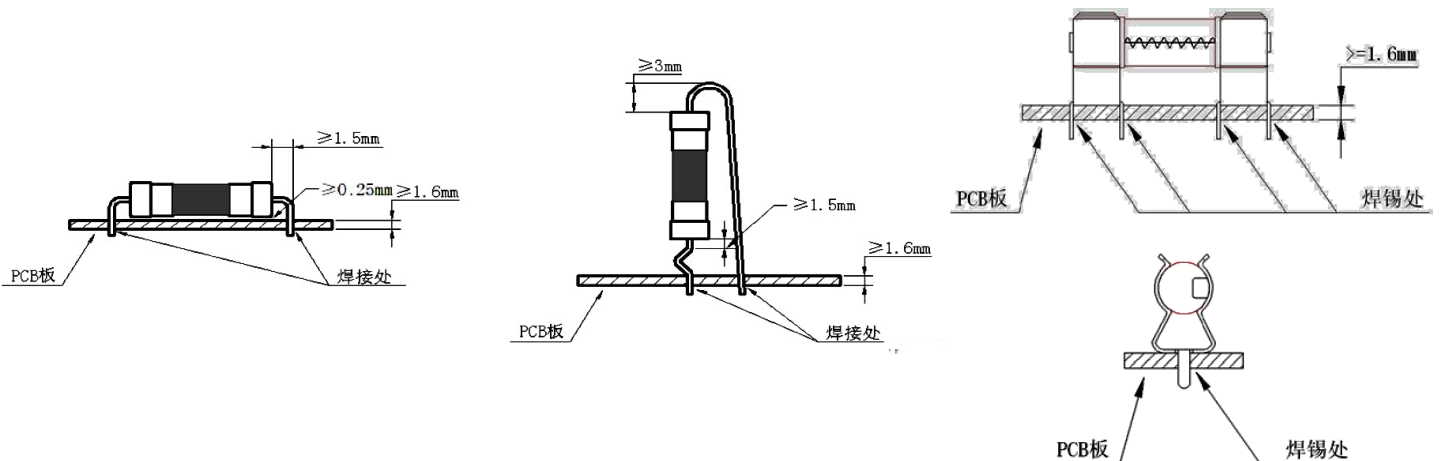

10-2 建议客户焊接参数 / Recommended Customer Soldering Parameters

波峰焊参数 / Wave Parameters:

锡炉温度 / Solder Pot Temperature:

260°C Max

焊接时间 / Solder Dwell Time:

2~5s

手工焊参数 / Hand-Solder Parameters:

烙铁温度 / Solder Iron Temperature:

350±5°C

焊接时间 / Heating Time:

5 s Max

11. 其他使用注意事项 / OTHER NOTICE IN USED

如果需在保险丝上加热缩套管，烘烤温度与时间需参照以下规定







If need to add heat draws back the sleeve pipe on the fuse, it needs to consult the following regulation to toast

temperature and time

温度 temperature	120°C	130°C	140°C	150°C	160°C	170°C	180°C
时间/time	Max 80s	Max 75s	Max 70s	Max 65s	Max 60s	Max 55s	Max 50s

12. 安全认证编号及分断能力 / SECURITY AUTHENTICATION CODE AND BREAKING CAPACITY

UL	E213695 (100mA~15A)
VDE	40012120 (100mA~10A)
CQC	CQC2002010207009016 (315mA~6.3A) CQC2019010207175619 (10A) CQC19012217062 (12.5A、16A) CQC21012323509 (20A)
CCC自我声明	2020970207000028 (315mA~6.3A) 2020970207000026 (10A)
PSE	JET7524-31003-1001 (100mA~5A) JET7524-31003-1002 (6.3A~15A)
KC	JU05001-3006D (1.25A~10A) HU05055-19001A (3.15A、4A、5A、6.3A)

Rated Current 额定电流	Rated Voltage 额定电压	Breaking Capacity 分断能力	Safety Approvals 安全认证					
								
100mA	250V	UL: ≤3.15A 35A@250V AC >2.5A 100A@250V AC VDE&CCC&KC: ≤3.15A 35A@250V AC >3.15A 10 IN@250V AC PSE: 1.25A~10A 100A@250V AC CQC: ≤3.15A 35A@250V AC >3.15A 10 IN@250V AC	●	●	○	●	○	○
200mA	250V		●	●	○	●	○	○
250mA	250V		●	●	○	●	○	○
315mA	250V		●	●	●	●	○	●
400mA	250V		●	●	●	●	○	●
500mA	250V		●	●	●	●	○	●
630mA	250V		●	●	●	●	○	●
800mA	250V		●	●	●	●	○	●
1A	250V		●	●	●	●	○	●
1.25A	250V		●	●	●	●	●	●
1.6A	250V		●	●	●	●	●	●
2A	250V		●	●	●	●	●	●
2.5A	250V		●	●	●	●	●	●
3A	250V		●	●	●	●	●	●
3.15A	250V		●	●	●	●	●	●
4A	250V		●	●	●	●	●	●
5A	250V		●	●	●	●	●	●
6.3A	250V		●	●	●	●	●	●
8A	250V		●	●	○	●	●	●
10A	250V		●	●	●	●	●	●
12.5A~15A	250V	●	○	○	●	○	●	
16A	250V	○	○	○	○	○	●	
20A	250V	○	○	○	○	○	●	

13. 包装数量 / Packing Quantity

A: 每内盒装 500 个保险丝。

500pcs per inner box .

B: 每外箱装 20内盒保险丝。

20 inner boxes per outer box .

14. 其他 / OTHERS

14-1 如果在使用中有超出本规格书的要求，必须经由双方协商确认。

In the event that an impropriety is found beyond this specification, it shall be fixed by mutual agreement between the parties.

14-2 PN编码规则见下表所示。

The PN encoding rules are shown in the table below

1	Part Numbering System (编码结构)						
2	FULL DESCRIPTION FORMAT (详细内容描述格式)						
	制造商Manufacturer	Series系列	Rated current额定电流	Rated voltage额定电压	Moulding&Packaging成型&包装	-	补充码
	xx	xxxxx	xxxx	x	xx		XX
	LB	RTG20	0125=125mA	A=250V	00=平头 散装		01=装砂防爆
		RTC20	1125=1.25A	B=125V	01=带常规引线 30mm 散装		
		RFG20	2125=12.5A	P=400V	02=带引线加长 38mm 散装		
		RFC20		R=500V	03=带引线加长 52mm 散装		
		RTG30		S=600V	04=带引线加粗 0.8 散装		
		RTC30		V=750V	05=带引线加粗 1.0 散装		
		RFG30			06=带引线加粗 1.2 散装		
		RFC30			07=立式成型 散装		
		630			08=卧式成型 散装		
					09=本体加套管卧式成型		
					10=本体及引线加套管立式成型		
3	Example例如:	P/N	RTG201200A00				
		规格描述	LB品牌 RTI-20 2A250V玻管保险丝 平头 散装				
		P/N	RTC201200A01-01				
		规格描述	LB品牌 RTI-20 2A250V陶瓷管保险丝 带常规引线 散装 装砂防爆				
		P/N	LB6302100V00				
		规格描述	LB品牌 LB630 10A750V 陶瓷管保险丝 平头散装				

14-3 如果本规格书有不适当的情况，必须通过双方协商并由本公司修改。

In the event that an impropriety is found in this specification , LANBAO ELECTRICAL APPLIANCES CO. LTD. Shall amend it by mutual agreement between the parties.

版次	制作	确认	审核
第 1 版	赖秋莲 2020/11/24	谢海林 2020/11/24	熊士军 2020/11/24



UL iQ for Fuses



Fuses

E213695

Guide Information

ZHONG SHAN LANBAO ELECTRICAL APPLIANCES CO LTD

West Xing Pu Rd, Huang Pu, Zhongshan Guangdong 528429 CN

RTI-20

Supplemental fuses

<u>Size</u> <u>mm(in)</u>	<u>Amps</u> <u>(A)</u>	<u>Volts</u> <u>(V)</u>	<u>Interrupting</u> <u>Rating (A)</u>
5.2 x 20 (0.20 x 0.79)	0.1 - 0.4	250Vac	35
	0.5 - 1.0	250Vac	35
	1.1 - 5.0	250Vac	100
	6.0 - 15	250Vac	100

Report Date: 2001-01-22

Last Revised: 2013-05-16

© 2020 UL LLC





UL iQ for Fuses



Fuses

E213695

Guide Information

ZHONG SHAN LANBAO ELECTRICAL APPLIANCES CO LTD

West Xing Pu Rd, Huang Pu, Zhongshan Guangdong 528429 CN

2T

Supplemental fuses

<u>Size</u> <u>mm(in)</u>	<u>Amps</u> <u>(A)</u>	<u>Volts</u> <u>(V)</u>	<u>Interrupting</u> <u>Rating (A)</u>
5.2 x 20 (0.20 x 0.79)	0.1 - 0.4	250Vac	35
	0.5 - 1.0	250Vac	35
	1.1 - 5.0	250Vac	100
	6.0 - 15	250Vac	100

Report Date: 2001-01-22

Last Revised: 2013-05-16

© 2021 UL LLC



ZEICHENGENEHMIGUNG MARKS APPROVAL

Zhongshan Lanbao Electrical
Appliances Co., Ltd.
102 West Xingpu Road, Huangpu
528429 ZHONG SHAN
Guangdong
CHINA

ist berechtigt, für ihr Produkt /
is authorized to use for their product

G-Sicherungseinsatz
Cartridge fuse-link
RTI-20 Serie(s) oder/lor
2T-Serie(s)

die hier abgebildeten markenrechtlich geschützten Zeichen
für die ab Blatt 2 aufgeführten Typen zu benutzen /
the legally protected Marks as shown below for the types referred to on page 2 ff.



Geprüft und zertifiziert nach /
Tested and certified according to

DIN EN 60127-1 (VDE 0820-1):2015-12; EN 60127-1:2006+A1:2011+A2:2015
DIN EN 60127-2 (VDE 0820-2):2015-07; EN 60127-2:2014
IEC 60127-1:2006
IEC 60127-1:2006/AMD1:2011
IEC 60127-1:2006/AMD2:2015
IEC 60127-2:2014

VDE Prüf- und Zertifizierungsinstitut GmbH
VDE Testing and Certification Institute
Zertifizierungsstelle / Certification

R. Nickel

VDE Zertifikate sind nur gültig bei Veröffentlichung unter:
VDE certificates are valid only when published on:

VDE

Aktenzeichen: 5002339-1170-0002 / 232614

File ref.:

Ausweis-Nr. 40012120

Blatt 1

Certificate No.

Page

Weitere Bedingungen siehe Rückseite und Folgeblätter /
further conditions see overleaf and following pages

Offenbach, 2004-11-04

(letzte Änderung / updated 2017-01-16)

<http://www.vde.com/zertifikat>
<http://www.vde.com/certificate>



Name und Sitz des Genehmigungs-Inhabers / Name and registered seat of the Certificate holder
Zhongshan Lanbao Electrical Appliances Co., Ltd., 102 West Xingpu Road, Huangpu, 528429 ZHONG SHAN,
Guangdong, CHINA

Aktenzeichen / File ref.
5002339-1170-0002 / 232614 / CC2 / EUL

letzte Änderung / updated Datum / Date
2017-01-16 2004-11-04

Dieses Blatt gilt nur in Verbindung mit Blatt 1 des Zeichengenehmigungsausweises Nr. 40012120.
This supplement is only valid in conjunction with page 1 of the Certificate No. 40012120.

G-Sicherungseinsatz Cartridge fuse-link RTI-20 Serie(s) oder/or 2T-Serie(s)

Typ(en) / Type(s)

RTI-20 Serie(s) oder/or 2T-Serie(s)

Bemessungsspannung <i>Rated voltage</i>	AC 250 V
Bemessungsstrom <i>Rated current</i>	100 mA; 200 mA; 250 mA; 315 mA; 400 mA; 500 mA; 630 mA; 800 mA; 1 A; 1,25 A; 1,6 A; 2 A; 2,5 A; 3,15 A; 4 A; 5 A; 6,3 A; 8 A; 10 A
Normblatt <i>Standard sheet</i>	3
Maße in mm <i>Dimension in mm</i>	5 x 20
Kennzeichnung der Charakteristik <i>Characteristic symbol</i>	T
Kennzeichnung des Ausschaltvermögens <i>Breaking capacity symbol</i>	L
Bemessungsausschaltvermögen <i>Rated breaking capacity</i>	35 A bzw. 10 x In 35 A resp. 10 x In
Zeit/Strom-Charakteristik <i>Time/current-characteristic</i>	träge time-lag

Fortsetzung siehe Blatt 3 /
continued on page 3



VDE Prüf- und Zertifizierungsinstitut Zeichengenehmigung

Ausweis-Nr. / Blatt /
Certificate No. / Page
40012120 3

Name und Sitz des Genehmigungs-Inhabers / *Name and registered seat of the Certificate holder*
Zhongshan Lanbao Electrical Appliances Co., Ltd., 102 West Xingpu Road, Huangpu, 528429 ZHONG SHAN,
Guangdong, CHINA

Aktenzeichen / *File ref.*
5002339-1170-0002 / 232614 / CC2 / EUL

letzte Änderung / *updated* Datum / *Date*
2017-01-16 2004-11-04

Dieses Blatt gilt nur in Verbindung mit Blatt 1 des Zeichengenehmigungsausweises Nr. 40012120.
This supplement is only valid in conjunction with page 1 of the Certificate No. 40012120.

Anmerkung
Remark

Die Prüfspannung in Abschnitt 9.2 war DC 125 V.
The test voltage in clause 9.2 was DC 125 V.

Dieser Zeichengenehmigungs-Ausweis bildet eine Grundlage für die EG-Konformitätserklärung und CE-Kennzeichnung durch den Hersteller oder dessen Bevollmächtigten und bescheinigt die Konformität mit den grundlegenden Schutzanforderungen der **EG-Niederspannungsrichtlinie 2014/35/EU**.
*This Marks Approval is a basis for the EC Declaration of Conformity and the CE Marking by the manufacturer or his agent and proves the conformity with the essential safety requirements of the **EC Low-Voltage Directive 2014/35/EU**.*

VDE Prüf- und Zertifizierungsinstitut GmbH
VDE Testing and Certification Institute
Fachgebiet CC2
Section CC2



VDE Prüf- und Zertifizierungsinstitut GmbH · Merianstraße 28 · 63069 Offenbach

VDE Global Services
Guangzhou Branch
Customer Service
Ms Echo Zou
2107-2110/21F, Peace World Plaza,
Nos. 362-366, Huan Shi Road (E)
510060 GUANGZHOU
Guangdong
CHINA

Offenbach, 2017-01-16

Ihr Zeichen
Your ref.

Ihr Schreiben
Your letter
2016-11-28

Unser Zeichen - bitte angeben
Our ref. - please indicate
5002339-1170-0002

Auftrag Nr.
Order No.
232614

Bearbeiter(in) kaufm.:
contact (order d.):
Vienna Zheng
Tel: +86 20 8375 2589
Fax: +86 20 8375 2576

Zeichengenehmigung Nr. 40012120
Marks Approval No.

Sehr geehrte Damen und Herren,

Sie erhalten heute eine Neuausfertigung des Zeichengenehmigungsausweises Nr. 40012120. Diese Neuausfertigung ersetzt zum 2017-01-16 den derzeit gültigen Zeichengenehmigungsausweis, welcher dann von Ihnen unverzüglich zu vernichten ist. Wir weisen darauf hin, dass die Herstellung von Produkten mit einem VDE-Zeichen nur dann gestattet ist, wenn eine gültige Zeichengenehmigung für diese Produkte besteht. Zuwiderhandlungen stellen einen Verstoß gegen die Prüf- und Zertifizierungsordnung (PM 102) dar.

Ladies and Gentlemen,

Please find enclosed a new version of the Marks Approval No. 40012120. This version replaces the currently valid approval as of 2017-01-16, which has to be destroyed by you immediately. We would like to inform you that the manufacturing of products with a VDE Mark is only permitted, if a valid approval has been issued for these products. Infringements to this are in violation of the Testing and Certification Procedure (PM 102).

Mit freundlichen Grüßen
Yours sincerely

VDE Prüf- und Zertifizierungsinstitut GmbH
VDE Testing and Certification Institute
Fachgebiet CC2
Section CC2

A COMPANY OF THE VDE ASSOCIATION FOR ELECTRICAL, ELECTRONIC & INFORMATION TECHNOLOGIES

Managing Director
EUR-Dipl.-Ing. Wolfgang Niedziella
Merianstraße 28
D-63069 Offenbach
e-mail: vde-institut@vde.co
http://www.vde.com

Venue:
Frankfurt am Main
HRB 43618
VAT-IDNo.: DE261922990
Tax No.: 04425092566
Phone: +49 (0) 69 83 06-0
Fax: +49 (0) 69 83 06-555

Make Payments to
Dresdner Bank Frankfurt
BLZ 500 800 00
Account-No.: 198 027 000
S.W.I.F.T.-Code:
DRES DE FF
IBAN:
DE 91500800000198027000

Notified Body according to the Product Safety Act (ProdSG) and the EMV Directive 2014/30/EU. Accredited according to DIN EN ISO/IEC 17025 and 17065.
Recognized Testing and Certification Body for GS Marks, for international IEC schemes (IECEE and IECQ) and European certification schemes (CCA, HAR, ENEC).





产品认证证书

证书编号: CQC2002010207009016

申请人名称及地址

中山市蓝宝电器有限公司
中山市黄圃镇兴圃大道西 102 号之三

制造商名称及地址

中山市蓝宝电器有限公司
中山市黄圃镇兴圃大道西 102 号之三

生产企业名称及地址

中山市蓝宝电器有限公司 (V002199)
中山市黄圃镇兴圃大道西 102 号之三

产品名称和系列、规格、型号

管状熔断体

RTI-20/2T T315mA L250V, RTI-20/2T T500mA L250V, RTI-20/2T T630mA L250V, RTI-20/2T T1A L250V, RTI-20/2T T1.6A L250V, RTI-20/2T T2A L250V, RTI-20/2T T2.5A L250V, RTI-20/2T T3.15A L250V, RTI-20/2T T4A L250V, RTI-20/2T T5A L250V, RTI-20/2T T6.3A L250V

产品标准和技术要求

GB/T9364. 1-2015; GB/T9364. 2-2018

认证模式

型式试验+初始工厂检查+获证后监督

上述产品符合 CQC11-462125-2018 认证规则的要求, 特发此证。

发证日期: 2020 年 07 月 12 日 有效期至: 2022 年 06 月 06 日
证书有效期内本证书的有效性依据发证机构的定期监督获得保持。

经中国合格评定国家认可委员会认可 CNAS C001-P

主任: 陆楠



中国质量认证中心

中国·北京·南四环西路 188 号 9 区 100070

<http://www.cqc.com.cn>

C 0326980



PRODUCT CERTIFICATE

CERTIFICATE NO.: CQC2002010207009016

NAME AND ADDRESS OF THE APPLICANT

Zhongshan Lanbao Electrical Appliances Co.,Ltd.
No.3, West 102, Xingpu Road, Huangpu Town, Zhongshan City, Guangdong Province

NAME AND ADDRESS OF THE MANUFACTURER

Zhongshan Lanbao Electrical Appliances Co.,Ltd.
No.3, West 102, Xingpu Road, Huangpu Town, Zhongshan City, Guangdong Province

NAME AND ADDRESS OF THE FACTORY

Zhongshan Lanbao Electrical Appliances Co.,Ltd. (V002199)
No.3, West 102, Xingpu Road, Huangpu Town, Zhongshan City, Guangdong Province

PRODUCT NAME, MODEL AND SPECIFICATION

Cartridge Fuse-link

RTI-20/2T T3.15mAL250V,RTI-20/2T T500mAL250V,RTI-20/2T T630mAL250V,RTI-20/2T T1AL250V,RTI-20/2T
T1.6AL250V,RTI-20/2T T2AL250V,RTI-20/2T T2.5AL250V,RTI-20/2T T3.15AL250V,RTI-20/2T T4AL250V,RTI-20/2T
T5AL250V,RTI-20/2T T6.3AL250V

THE STANDARDS AND TECHNICAL REQUIREMENTS FOR THE PRODUCTS

GB/T9364.1-2015;GB/T9364.2-2018

TYPE OF CERTIFICATION SCHEMES

Type testing of product + initial factory inspection + follow up factory inspection

This is to certify that the above mentioned product(s) complies with the requirements of certification rules of CQC11-462125-2018 .

Valid from: Jul.12,2020

Valid until: Jun.06,2022

The validity of the certificate is subject to positive result of the regular follow up inspection by issuing certification body until the expiry date.

Accredited by China National Accreditation Service for Conformity Assessment CNAS C001-P

President: _____

Lu Mei



CHINA QUALITY CERTIFICATION CENTRE

Section 9, No.188, Nansihuan Xilu, Beijing 100070 P.R.China
<http://www.cqc.com.cn>

C 0326980



产品认证证书

证书编号：CQC2019010207175619

申请人名称及地址

中山市蓝宝电器有限公司
中山市黄圃镇兴圃大道西102号之三

制造商名称及地址

中山市蓝宝电器有限公司
中山市黄圃镇兴圃大道西102号之三

生产企业名称及地址

中山市蓝宝电器有限公司(V002199)
中山市黄圃镇兴圃大道西102号之三

产品名称和系列、规格、型号

管状熔断体

RTI-20 T10AH250V

产品标准和技术要求

GB/T9364.1-2015;GB/T9364.2-2018

认证模式

型式试验+初始工厂检查+获证后监督

上述产品符合 CQC11-462125-2018 认证规则的要求，特发此证。

发证日期：2020年07月12日 有效期至：2024年04月22日

证书有效期内本证书的有效性依据发证机构的定期监督获得保持。

主任：_____

陆楠



中国质量认证中心

中国·北京·南四环西路188号9区100070

<http://www.cqc.com.cn>

C 0326983



PRODUCT CERTIFICATE

CERTIFICATE NO.: CQC2019010207175619

NAME AND ADDRESS OF THE APPLICANT

Zhongshan Lanbao Electrical Appliances Co.,Ltd.
No.3, West 102, Xingpu Road, Huangpu Town, Zhongshan City, Guangdong Province

NAME AND ADDRESS OF THE MANUFACTURER

Zhongshan Lanbao Electrical Appliances Co.,Ltd.
No.3, West 102, Xingpu Road, Huangpu Town, Zhongshan City, Guangdong Province

NAME AND ADDRESS OF THE FACTORY

Zhongshan Lanbao Electrical Appliances Co.,Ltd. (V002199)
No.3, West 102, Xingpu Road, Huangpu Town, Zhongshan City, Guangdong Province

PRODUCT NAME, MODEL AND SPECIFICATION

Cartridge fuse-links
RTI-20 T10AH250V

THE STANDARDS AND TECHNICAL REQUIREMENTS FOR THE PRODUCTS

GB/T9364.1-2015;GB/T9364.2-2018

TYPE OF CERTIFICATION SCHEMES

Type testing of product + initial factory inspection + follow up factory inspection

This is to certify that the above mentioned product(s) complies with the requirements of certification rules of CQC11-462125-2018 .

Valid from: Jul.12,2020

Valid until: Apr.22,2024

The validity of the certificate is subject to positive result of the regular follow up inspection by issuing certification body until the expiry date.

President:

Lu Mei



CHINA QUALITY CERTIFICATION CENTRE

Section 9, No.188, Nansihuan Xilu, Beijing 100070 P.R.China
<http://www.cqc.com.cn>

C 0326983



产品认证证书

证书编号: CQC19012217062

申请人名称及地址

中山市蓝宝电器有限公司
中山市黄圃镇兴圃大道西 102 号之三

制造商名称及地址

中山市蓝宝电器有限公司
中山市黄圃镇兴圃大道西 102 号之三

生产企业名称及地址

中山市蓝宝电器有限公司 (V002199)
中山市黄圃镇兴圃大道西 102 号之三

产品名称和系列、规格、型号

特殊应用的小型熔断体(管状)

RTI-20 12.5A a.c. 250V、 RTI-20 16A a.c. 250V (额定分断能力: 500A, 主要尺寸:
Φ5.2mm×20mm)

产品标准和技术要求

GB/T 9364.1-2015; GB/T 9364.7-2016

认证模式

产品型式试验+初次工厂检查+获证后监督

上述产品符合 CQC11-462125-2018 认证规则的要求, 特发此证。

发证日期: 2019 年 04 月 22 日

本证书的有效性依据发证机构的定期监督获得保持。

主任: _____

陆梅



中国质量认证中心

中国·北京·南四环西路 188 号 9 区 100070

<http://www.cqc.com.cn>

C 0144746



PRODUCT CERTIFICATE

CERTIFICATE NO.: CQC19012217062

NAME AND ADDRESS OF THE APPLICANT

Zhongshan Lanbao Electrical Appliances Co.,Ltd.
No.3, West 102, Xingpu Road, Huangpu Town, Zhongshan City, Guangdong Province

NAME AND ADDRESS OF THE MANUFACTURER

Zhongshan Lanbao Electrical Appliances Co.,Ltd.
No.3, West 102, Xingpu Road, Huangpu Town, Zhongshan City, Guangdong Province

NAME AND ADDRESS OF THE FACTORY

Zhongshan Lanbao Electrical Appliances Co.,Ltd. (V002199)
No.3, West 102, Xingpu Road, Huangpu Town, Zhongshan City, Guangdong Province

PRODUCT NAME, MODEL AND SPECIFICATION

Miniature fuse-links for special applications
RTI-20 12.5A a.c. 250V、 RTI-20 16A a.c. 250V (额定分断能力: 500A, 主要尺寸: $\Phi 5.2\text{mm} \times 20\text{mm}$)

THE STANDARDS AND TECHNICAL REQUIREMENTS FOR THE PRODUCTS

GB/T 9364.1-2015;GB/T 9364.7-2016

TYPE OF CERTIFICATION SCHEMES

Type Testing of Product + Initial Factory Inspection + Follow up Factory Inspection

This is to certify that the above mentioned product(s) complies with the requirements of certification rules of CQC11-462125-2018 .

Valid from: Apr.22,2019

The validity of the certificate is subject to positive result of the regular follow up inspection by issuing certification body.

President: _____

Lu Mei



CHINA QUALITY CERTIFICATION CENTRE

Section 9, No.188, Nansihuan Xilu, Beijing 100070 P.R.China
<http://www.cqc.com.cn>

C 0144746



产品认证证书

证书编号: CQC21012323509

发证日期: 2021年12月08日

有效期至: 2026年12月08日

**委托人名称
及注册地址** 中山市蓝宝电器有限公司
中山市黄圃镇兴圃大道西102号之三

**制造商名称
及注册地址** 中山市蓝宝电器有限公司
中山市黄圃镇兴圃大道西102号之三

**生产企业名称
及生产地址** 中山市蓝宝电器有限公司
中山市黄圃镇兴圃大道西102号之三

**产品名称和系列、
规格、型号** 特殊应用的小型熔断体(管状)
RTI-20 20A a.c. 250V / d.c. 500V(额定分断能力: 300A, 主要尺寸: $\Phi 5.2\text{mm} \times 20\text{mm}$)

产品标准和技术要求 GB/T 9364.1-2015;GB/T 9364.7-2016

认证模式 产品型式试验+初次工厂检查+获证后监督

上述产品符合 CQC11-462125-2018 认证规则的要求, 特发此证。
证书有效期内本证书的有效性依据发证机构的定期监督获得保持。

可通过扫描下方二维码或登录国家认监委网站 (www.cnca.gov.cn) 查验证书信息



签发: 谢肇煦



中国质量认证中心



强制性认证产品符合性自我声明



自我声明编号：2020970207000028

中山市蓝宝电器有限公司（生产者） 确认知晓《强制性产品认证自我声明实施规则》以及相关产品强制性认证实施规则的要求，对本声明承担全部法律责任。

中山市蓝宝电器有限公司（生产者） 声明以下产品已按照《强制性产品认证自我声明实施规则》以及相关产品强制性认证实施规则的要求进行检测，符合相关标准要求；自本声明签署之日起，生产和销售的产品持续符合以下标准与实施规则的要求；保存本声明涉及的技术文档至少10年；正确使用强制性产品认证标志；如产品或其符合性信息发生变更，将及时更新技术文档并报送产品变更信息。

生产者名称： 中山市蓝宝电器有限公司
生产者地址： 广东省中山市黄圃镇兴圃大道西102号之三
依据的强制性产品认证规则： CNCA-C02-01:2014 电路开关及保护或连接用电器装置（电器附件）
产品名称： 管状熔断体
产品系列、型号、规格： （见附页）
依据的标准： GB/T9364. 1-2015;GB/T9364. 2-2018
生产企业名称： 中山市蓝宝电器有限公司
生产企业地址： 中山市黄圃镇兴圃大道西102号之三

联系人： 熊士军
电话： 0760-23226150
电子邮箱： lanbaofuse@163.com
指定签字人：

自我声明时间： 2020-04-14
自我声明地点： 中山市
生产者签章：

注：有关本声明信息真伪可登录全国认证认可信息公共服务平台（cx.cnca.cn）或扫描右上角二维码查询。

强制性认证产品符合性自我声明(附页)



自我声明编号: 2020970207000028

产品系列、型号、规格:

RTI-20/2T T315mAL250V, RTI-20/2T T500mAL250V, RTI-20/2T T630mAL250V, RTI-20/2T T1AL250V, RTI-20/2T T1.6AL250V, RTI-20/2T T2AL250V, RTI-20/2T T2.5AL250V, RTI-20/2T T3.15AL250V, RTI-20/2T T4AL250V, RTI-20/2T T5AL250V, RTI-20/2T T6.3AL250V

联系人: 熊士军
电话: 0760-23226150
电子邮箱: lanbaofuse@163.com
指定签字人:

自我声明时间: 2020-04-14
自我声明地点: 中山市

生产者签章:

注: 有关本声明信息真伪可登录全国认证认可信息公共服务平台 (cx.cnca.cn) 或扫描右上角二维码查询。

强制性认证产品符合性自我声明



自我声明编号：2020970207000026

中山市蓝宝电器有限公司（生产者） 确认知晓《强制性产品认证自我声明实施规则》以及相关产品强制性认证实施规则的要求，对本声明承担全部法律责任。

中山市蓝宝电器有限公司（生产者） 声明以下产品已按照《强制性产品认证自我声明实施规则》以及相关产品强制性认证实施规则的要求进行检测，符合相关标准要求；自本声明签署之日起，生产和销售的产品持续符合以下标准与实施规则的要求；保存本声明涉及的技术文档至少10年；正确使用强制性产品认证标志；如产品或其符合性信息发生变更，将及时更新技术文档并报送产品变更信息。

生产者名称： 中山市蓝宝电器有限公司
生产者地址： 广东省中山市黄圃镇兴圃大道西102号之三
依据的强制性产品认证规则： CNCA-C02-01:2014 电路开关及保护或连接用电器装置（电器附件）
产品名称： 管状熔断体
产品系列、型号、规格： RTI-20 T10AH250V
依据的标准： GB/T9364.1-2015;GB/T9364.2-2018
生产企业名称： 中山市蓝宝电器有限公司
生产企业地址： 中山市黄圃镇兴圃大道西102号之三

联系人： 熊士军
电话： 0760-23226150
电子邮箱： lanbaofuse@163.com
指定签字人：

自我声明时间： 2020-04-14
自我声明地点： 中山市
生产者签章：

2018年12月21日

December 21, 2018

ZHONGSHAN LANBAO ELECTRICAL APPLIANCES CO.,
LTD.
GENERAL MANAGER XIONG SHILI

東京都渋谷区代々木5-14-12
一般財団法人 電気安全環境研究所
製品認証部

5-14-12, Yoyogi, Shibuya-Ku, Tokyo
Japan Electrical Safety & Environment technology Laboratories (JET)
Product Certification Division

2018年11月 6日 付けでお申込みいただきました下記の特定期間電気用品に
つきましては、同封の適合同等証明書のとおり 2018年12月21日付にて
交付され、 2025年12月20日まで有効であることをお知らせします。

I hereby inform you that with respect to the application of Nov. 6, 2018, for conformity assessment for the
specified product hereunder, the certificate, as enclosed herewith, was issued on Dec 21, 2018 and the term
of validity of this certificate is from the date of its issue to Dec 20, 2025.

記

1. 受付番号 : A18T0826

Project No.

2. 特定電気用品名 : 管形ヒューズ

Name of Product

Cartridge fuses

3. 製品の型 : RTI-20/RFI-20

Model

4. 証明書番号 : JET7524-31003-1001

Statement Number

5. 製造工場名 (Manufacturer)

住 所 : NO.102 XINPU ROAD, HUANGPU TOWN, ZHONGSHAN CITY,
Address GUANGDONG, CHINA

氏名又は名称 : ZHONGSHAN LANBAO ELECTRICAL APPLIANCES CO., LTD.
Name

6. 型式 : (Type)

250V, 5A, 銅合金1, 充てん物なし, ガラス筒, 筒形端子, 排気孔なし, 溶断表
示なし, 電子機器用, 遮断電流100A

適合同等証明書

Statement of Conformity Assessment

電気用品安全法第8条第1項に規定する技術基準及び同法第9条第2項の経済産業省令で定める基準（法第9条第1項第2号に係る検査に係るものに限る）に適合していることを証明します

I hereby certify that the product mentioned below complies with the technical requirements stipulated in Paragraph 1 of Article 8 of Electrical Appliances and Materials Safety Act (here under referred to as the Act) and the requirements defined by the ordinance of the Ministry of Economy, Trade and Industry based on Paragraph 2 of Article 9 of the Act (limited to Item 2 of Paragraph 1 of Article 9 for Inspection of the Act).

1. 証明書番号: JET7524-31003-1001

Statement Number

2. 交付年月日: 2018年12月21日

Effective Date

December 21, 2018

3. 有効年月日: 2025年12月20日

Date of Validity

December 20, 2025

4. 申込者名 (Applicant)

住所: NO. 102 XINPU ROAD, HUANGPU TOWN, ZHONGSHAN CITY, GUANGDONG, CHINA

氏名又は名称: ZHONGSHAN LANBAO ELECTRICAL APPLIANCES CO., LTD.
Name

5. 特定電気用品名: 管形ヒューズ

Name of Product

Cartridge fuses

6. 型式の区分: 別紙のとおり

Type Classification

See attached "Type Classification"

7. 製造工場名 (Manufacturer)

住所: NO. 102 XINPU ROAD, HUANGPU TOWN, ZHONGSHAN CITY, GUANGDONG, CHINA

氏名又は名称: ZHONGSHAN LANBAO ELECTRICAL APPLIANCES CO., LTD.
Name

8. 適用試験規格: 電気用品の技術上の基準を定める省令の解釈

Applied Standard for Testing

Description of the technical requirements by the METI Ordinance

別表第三 2

Appendix 3 Section 2

9. 適合性検査の方法: (Testing Method for Conformity Assessment)

1) 試験用の特定電気用品については、電気用品の技術上の基準を定める省令の解釈に定める方法

With respect to testing for Category A products, the testing method is based on the technical requirements of the description of Electrical Appliances and Materials stipulated in the METI Ordinance.

2) 当該特定電気用品に係る届出事業者又は事業場における検査設備については、電気用品安全法施行規則別表第四の検査設備の欄に掲げる検査設備ごとにそれぞれ同表の技術上の基準の欄に掲げる方法

With respect to inspection facilities required for Category A products at the factory, Testing Method described in the column of the technical requirements for each inspection facilities in the column of inspection facilities is shown in the Appendix 4 of Enforcement Regulations of the Act.

10. 注意事項

- 1) この適合同等証明書は、提出された試験用の電気用品に関して評価を行った上で交付したものであり、同一の型式の区分にある電気用品について電気用品安全法第8条1項に規定する技術基準適合確認の義務を履行したことを示すものではありません。

This Statement of Conformity Assessment, which is issued on the evaluation of the submitted test-use Electrical Appliances and Materials, does not signify that the Obligation to Comply with Requirements, which is prescribed at Paragraph 1 of Article 8 of the Act, is fulfilled on Electrical Appliances and Materials in the same Type Classification.

- 2) この適合同等証明書は、別紙に記載されている型式の区分の範囲内及び区分の組み合わせについてのみ有効です。

This Statement of Conformity Assessment is valid only for Electrical Appliances and Materials within the Type Classifications and their combination as stated in the attached "Type Classification".

一般財団法人 電気安全環境研究所
Japan Electrical Safety & Environment technology Laboratories (JET)

理事長 薦田 康久
President Yasuhisa Komoda

東京都渋谷区代々木5-14-12
(5-14-12, Yoyogi, Shibuya-ku, Tokyo, Japan)

証明書番号: JET7524-31003-1001

適合同等証明書別紙

Statement of Conformity Assessment

型式の区分

Type Classification

要素 Factor	区分 Classification
定格電圧 Rated voltage	(2) 125Vを超えるもの Exceeding 125V
定格電流（定格電流表示のあるものの場合に限る。） Rated current (limited to those with rated current markings)	(1) 5 A以下のもの 5A or less
適用電動機の定格容量（定格電流表示のないものの場合に限る。） Rated capacity of applicable motor (limited to those without rated current markings)	—
可溶体の主材料 Fuse element materials	(5) 銅のもの Copper
可溶体の数 Number of fuse elements	(1) 1のもの One
再使用（管形ヒューズを除く。） Reusability (excluding cartridge fuses)	—
内部充てん物 Filler materials	(2) ないもの Without filler materials
筒（内筒を除く。）の材料 Outer cartridge materials	(3) 磁器のもの又はガラスのもの Ceramic or glass
端子 Terminals	(2) 筒形のもの Tubular terminal
排気孔 Exhausting opening	(2) ないもの Without exhausting opening
溶断の表示 Blowout fuse indicator	(2) ないもの Without blowout fuse indicator
用途 Application	(2) 電子機器用のもの For use in electric appliances
定格遮断電流 Rated breaking capacity	(1) 100 A以下のもの 100A or less

2018年12月21日

December 21, 2018

ZHONGSHAN LANBAO ELECTRICAL APPLIANCES CO.,
LTD.
GENERAL MANAGER XIONG SHILI

東京都渋谷区代々木5-14-12
一般財団法人 電気安全環境研究所
製品認証部

5-14-12, Yoyogi, Shibuya-Ku, Tokyo
Japan Electrical Safety & Environment technology Laboratories (JET)
Product Certification Division

2018年11月 6日 付けでお申込みいただきました下記の特定期間電気用品に
つきましては、同封の適合等証明書のとおり 2018年12月21日付にて
交付され、2025年12月20日まで有効であることをお知らせします。

I hereby inform you that with respect to the application of Nov. 6, 2018, for conformity assessment for the
specified product hereunder, the certificate, as enclosed herewith, was issued on Dec 21, 2018 and the term
of validity of this certificate is from the date of its issue to Dec 20, 2025.

記

1. 受付番号 : A18T0827
Project No.
2. 特定電気用品名 : 管形ヒューズ
Name of Product Cartridge fuses
3. 製品の型 : RTI-20/RFI-20
Model
4. 証明書番号 : JET7524-31003-1002
Statement Number
5. 製造工場名 (Manufacturer)
住所 : NO.102 XINPU ROAD, HUANGPU TOWN, ZHONGSHAN CITY,
Address GUANGDONG, CHINA
氏名又は名称 : ZHONGSHAN LANBAO ELECTRICAL APPLIANCES CO., LTD.
Name
6. 型式 : (Type)
250V, 8A, 銅合金1, 充てん物なし, ガラス筒, 筒形端子, 排気孔なし, 溶断表
示なし, 電子機器用, 遮断電流100A

適合同等証明書

Statement of Conformity Assessment

電気用品安全法第8条第1項に規定する技術基準及び同法第9条第2項の経済産業省令で定める基準（法第9条第1項第2号に係る検査に係るものに限る）に適合していることを証明します

I hereby certify that the product mentioned below complies with the technical requirements stipulated in Paragraph 1 of Article 8 of Electrical Appliances and Materials Safety Act (here under referred to as the Act) and the requirements defined by the ordinance of the Ministry of Economy, Trade and Industry based on Paragraph 2 of Article 9 of the Act (limited to Item 2 of Paragraph 1 of Article 9 for Inspection of the Act).

1. 証明書番号: JET7524-31003-1002
Statement Number

2. 交付年月日: 2018年12月21日
Effective Date December 21, 2018

3. 有効年月日: 2025年12月20日
Date of Validity December 20, 2025

4. 申込者名 (Applicant)

住所: NO. 102 XINPU ROAD, HUANGPU TOWN, ZHONGSHAN CITY, GUANGDONG, CHINA
Address

氏名又は名称: ZHONGSHAN LANBAO ELECTRICAL APPLIANCES CO., LTD.
Name

5. 特定電気用品名: 管形ヒューズ
Name of Product Cartridge fuses

6. 型式の区分: 別紙のとおり
Type Classification See attached "Type Classification"

7. 製造工場名 (Manufacturer)

住所: NO. 102 XINPU ROAD, HUANGPU TOWN, ZHONGSHAN CITY, GUANGDONG, CHINA
Address

氏名又は名称: ZHONGSHAN LANBAO ELECTRICAL APPLIANCES CO., LTD.
Name

8. 適用試験規格: 電気用品の技術上の基準を定める省令の解釈
Applied Standard for Testing Description of the technical requirements by the METI Ordinance

別表第三

Appendix 3 Section 2

9. 適合性検査の方法: (Testing Method for Conformity Assessment)

1) 試験用の特定電気用品については、電気用品の技術上の基準を定める省令の解釈に定める方法

With respect to testing for Category A products, the testing method is based on the technical requirements of the description of Electrical Appliances and Materials stipulated in the METI Ordinance.

2) 当該特定電気用品に係る届出事業者又は事業場における検査設備については、電気用品安全法施行規則別表第四の検査設備の欄に掲げる検査設備ごとにそれぞれ同表の技術上の基準の欄に掲げる方法

With respect to inspection facilities required for Category A products at the factory, Testing Method described in the column of the technical requirements for each inspection facilities in the column of inspection facilities is shown in the Appendix 4 of Enforcement Regulations of the Act.

10. 注意事項

- 1) この適合同等証明書は、提出された試験用の電気用品に関して評価を行った上で交付したものであり、同一の型式の区分にある電気用品について電気用品安全法第8条1項に規定する技術基準適合確認の義務を履行したことを示すものではありません。

This Statement of Conformity Assessment, which is issued on the evaluation of the submitted test-use Electrical Appliances and Materials, does not signify that the Obligation to Comply with Requirements, which is prescribed at Paragraph 1 of Article 8 of the Act, is fulfilled on Electrical Appliances and Materials in the same Type Classification.

- 2) この適合同等証明書は、別紙に記載されている型式の区分の範囲内及び区分の組み合わせについてのみ有効です。

This Statement of Conformity Assessment is valid only for Electrical Appliances and Materials within the Type Classifications and their combination as stated in the attached "Type Classification".

一般財団法人 電気安全環境研究所
Japan Electrical Safety & Environment technology Laboratories (JET)

理事長 薦田 康久
President Yasuhisa Komoda

東京都渋谷区代々木5-14-12
(5-14-12, Yoyogi, Shibuya-ku, Tokyo, Japan)

証明書番号: J E T 7 5 2 4 - 3 1 0 0 3 - 1 0 0 2

適合同等証明書別紙

Statement of Conformity Assessment

型式の区分

Type Classification

要素 Factor	区分 Classification
定格電圧 Rated voltage	(2) 125Vを超えるもの Exceeding 125V
定格電流（定格電流表示のあるものの場合に限る。） Rated current (limited to those with rated current markings)	(2) 5 Aを超え15 A以下のもの Exceeding 5A, and less than or equal to 15A
適用電動機の定格容量（定格電流表示のないものの場合に限る。） Rated capacity of applicable motor (limited to those without rated current markings)	—
可溶体の主材料 Fuse element materials	(5) 銅のもの Copper
可溶体の数 Number of fuse elements	(1) 1のもの One
再使用（管形ヒューズを除く。） Reusability (excluding cartridge fuses)	—
内部充てん物 Filler materials	(2) ないもの Without filler materials
筒（内筒を除く。）の材料 Outer cartridge materials	(3) 磁器のもの又はガラスのもの Ceramic or glass
端子 Terminals	(2) 筒形のもの Tubular terminal
排気孔 Exhausting opening	(2) ないもの Without exhausting opening
溶断の表示 Blowout fuse indicator	(2) ないもの Without blowout fuse indicator
用途 Application	(2) 電子機器用のもの For use in electric appliances
定格遮断電流 Rated breaking capacity	(1) 100 A以下のもの 100A or less

証明書番号：JET7524-31003-1002



전기용품 안전 인증서

Electrical Appliances Safety Certificate

안전인증번호 : JU05001-3006D
(Certificate No.)

제조업자명 : Zhongshan Lanbao Electrical Appliances Co.,Ltd
(Manufacturer)

대표자명 : Yang Han Bin
(President)

제조공장의 소재지 : 102 Xin Pu Road Huang Pu, Zhongshan, Guangdong China
(Factory Address)

제품명 : 소형퓨즈
(Product) (Miniature fuse)

기본모델명 : 21GT 250V 1.25A ~ 10A
(Basic Model)

정격 : 250 V, 1.25 A ~ 10 A, 100 A, a Type
(Rating)

파생모델명 : 22GT 250V 1.25A ~ 10A, 51ST 250V 1.25A ~ 10A
(Series Model) 52ST 250V 1.25A ~ 10A

적용기준 : Technical Standards for Electrical Appliance 02
(Standard)

「전기용품안전 관리법 시행규칙」 제6조제2항의 규정에 따라 위의 전기용품에 대하여 안전인증서를 교부합니다.

We Issue Electrical Appliances Safety Certification as above product by Article 6 Section 2 of the Electrical Appliances Safety Control Enforcement Regulation.

2011년 11월 21일
year month day



한국화학융합시험연구원

(KOREA TESTING & RESEARCH INSTITUTE)



이 인증서는 「전기용품안전관리법」에 따른 전기용품안전성 확인에 한정된 것이며 그 밖의 다른 법률이 적용되는 제품의 경우에는 해당법률에 따라 추가로 인증허가 등을 받아야 합니다.

- 1. 안전관리부품 및 재질목록(List of Critical Components)
- 첨부서류 2. 기본모델·파생모델의 내용(General Descriptions of Certified Products)
- (Annex) 3. 전기용품안전인증의 변경 현황(Status of Certificate Revisions)

※ 안전인증 시의 조건 : 동 제품의 생산 시 자체검사를 실시하고 안전인증 시 등록된 부품누락 및 임의 변경하지 말 것.

Certification No. : JU05001-3006D

[Attachment 1 : List of Critical Components]

1/1

Component/ part No.	Manufacturer/ trademark	Model/type	Technical data	Mark(s) of conformity
Fusible Material	Heesung Metal Ltd	-	10% Ag Coated Cu	-
	Shin Il Metic			
Tube Type Terminal	Poong San	-	Brass	-
Tube	Hankoon Glass	-	Glass Outer diameter : 5.2mm Length : 20.0mm	-
Solder	Heesung Metal Ltd	-	Pb 63%, Sn 36% Flux 1%	-

※ Attention

1. As the critical components and parts are directly related with safety, these components shall be checked during a factory inspection by the certification body. In case of applying for multiple listings or changes for the items above, the certification revision shall be applied.
2. The safety certification will be cancelled under the Electrical Appliance Safety Control Law, Clause 1 of Article 8 if the contents of the certification are altered without prior authorization.
3. Handling criteria for non-conforming electrical appliance
 - 1) Added in new items and test items for conventional track shall be subject to existing similar items
 - 2) In case of the products without the validation process by a safety certification body and randomly missing paths such as adding and changing some components, unlike a safety certificate or a registration for the self-regulatory safety confirmation and other related regulations shall apply most serious level of defect)

Certification No. : JU05001-3006D

[Attachment 2 : General Description of Certified Products]

1/1

Series model(s)	Difference between the basic and variant models	Remarks
22GT 250V 1.25A ~ 10A	o Lead wire is attached	
51ST 250V 1.25A ~ 10A	o Different model name for basic model (For model name identification in market)	
52ST 250V 1.25A ~ 10A	o Lead wire is attached o Different model name from variant model (22GT 250V 1.25A ~ 10A) o For model name identification in market	

Features and Specifications

o Usage

- It is used to protect overcurrent for electric appliances
- Inner structure : Comprised of solder, fusible material in glass case
- Outer structure : It is fixed to fuse holder

o Specifications

- Rated : 250 V, 1.25 A ~ 10 A, 100 A, a Type

* If you have questions on product testing contents, please contact the following :

- Division of Conformity Testing
- Tel : 82-31-679-9600 Fax : 82-31-336-2427

Certification No. : JU05001-3006D

[Attachment 3 : Status of Compliance Certificate Revision]

1/1

Date	Content of revision	Reference
2003. 10. 20	o Variant models are added (51ST 250V 1.25A ~ 10A, 52ST 250V 1.25A ~ 10A)	
2004. 4. 1	o Name of Manufacturer is changed - Before : Dandong Daewon Automobile Co.,Ltd) o Address of Factory is changed - Before : 6F Bldg 1 Jianwan Export Processing Section Dandong Liaoning China	
2006. 2. 14	o Name of Manufacturer is changed - Before : Zhongshan Lanbao Electrical Appliances Co.,Ltd (Daewon LB Fuse)	
2011. 11. 21	o Reissue by manufacturer at request certificate	